



ATEX
Certified

YB3系列 Series YB3

隔爆型三相异步电动机 Flameproof Three Phase Induction Motors

地址: 中国江苏省靖江市季市西路39号
电话: 0086-523-84542326 84542309
传真: 0086-523-84542280 邮编: 214523
网址: <http://www.dzem-china.com>

ADD: NO.39 JISHI, JINGJIANG CITY,JIANGSU,CHINA
TEL: 0086-523-84542326 84542309
FAX: 0086-523-84542280 POST CODE: 214523
E-mail: jjdzjd@pub.tz.jsinfo.net



江苏大中电机股份有限公司

JIANGSU DAZHONG ELECTRIC MOTOR CO.,LTD.

概述

YB3系列隔爆型三相异步电动机是我公司YB2系列的更新换代的隔爆型电动机基本系列，本系列电动机具有体积小、重量轻、外形美观、安全可靠运行、寿命长、性能优良，安装使用维修方便。

本系列电动机的功率等级、安装尺寸符合国际电工委员会（IEC）标准，其对应关系与德国DIN42673标准相同，有利于出口设备的配套和引进设备的备品备件。

本系列电动机隔爆性能符合GB3836.1-2010《爆炸性环境第1部分：设备 通用要求》和GB3836.2-2010《爆炸性环境第2部分：由隔爆外壳“d”保护的设备的》规定，也符合IEC79-1，BS4683和EN50018的规定制成隔爆型。防爆标志为Ex d I Mb、Ex d II A T4 Gb、Ex d II B T4 Gb，适用于爆炸性环境的场所。

Ex d I Mb 安装在煤矿甲烷爆炸性环境中的设备，具有“高”的保护级别，该级别具有足够的安全性，使设备正常运行中或在气体突然出现和设备断电之间的时间内出现的预期故障条件下不可能成为点燃源，适用于非采掘工作面用电气设备。

Ex d II A T4 Gb、Ex d II B T4 Gb 适用于除煤矿外爆炸性气体环境用设备，具有“高”的保护级别，在正常运行或预期故障条件下不是点燃源。

在YB3基本系列电动机基础上，也可制成YB3-W户外型、YB3-TH户内湿热带型、YB3-WTH户外湿热带型。YB3-TA户内干热带型、YB3-WTA户外干热带型、YB3-T户内热带型、YB3-WT户外热带型及YB3-WF1户外中等防腐蚀型等气候环境条件。

该系列电动机效率指标符合GB18613-2012《中小型三相异步电动机能效限定值及能效等级》中规定的能效3级的效率值与IEC60034-30的IE2保持一致。

General Description

YB3 series flameproof type three-phase asynchronous motor is our upgraded explosion-proof motor basic series from YB2 series, the series motor has the advantages of small volume, light weight, beautiful appearance, reliable operation, long service life, excellent performance as well as convenient installation, operation and maintenance.

The series motor's power level, installation dimensions comply with IEC standard, with coincident corresponding relationship with German standard DIN42673. It is conducive for the export equipment matching and introduction of spare parts for equipments.

The series motor's flameproof performance is in accordance with GB3836.1-2010 Explosive atmospheres-Part 1: Equipment. General requirements & GB3836.2-2010 Explosive atmosphere-Part 2: equipment with flameproof enclosure “d” protection, it was also made into flameproof type in accordance with IEC79-1, BS4683 & EN50018 provision. The flameproof mark is Ex d I Mb, Ex d II A T4 Gb, Ex d II B T4 Gb, which is applicable for explosive atmosphere.

For Ex d I Mb, equipment installed at coal mine methane explosive environment, has “high” protection level. This level has sufficient safe performance, it cause impossibility to be the ignition source during equipment normal running, or under expected failure conditions for the period between gas suddenly appeared and equipment power off, it is applicable for electrical equipment for non excavation working face.

Ex d II A T4 Gb, Ex d II B T4 Gb are applicable for equipments with explosive gas environment except coal mine, with “high” protection level, it is not a source of ignition during normal running or under expected fault conditions.

Based on YB3 basic series motor, it can also be made into YB3-W outdoor type, YB3-TH indoor humid tropics type, YB3-WTH outdoor humid tropics type. YB32-TA indoor dry tropics type, YB3-WTA outdoor dry tropics type, YB3-T indoor tropics type, YB3-WT outdoor tropics type & YB3-WF1 outdoor medium corrosion type etc. climate conditions.

The series motor efficiency index reaches grade 3 efficiency rating specified in The minimum allowable values of energy efficiency and the energy efficiency grades for small and medium three-phase asynchronous motors, GB18613-2012 standard, which is equivalent to the IE2 of IEC60034-30.

大 中 小 机

电动机防爆标志代表的意义 Explanation of Ex marking and designation



电动机型号代表的意义 Explanation of type designation



结构说明

1. 电动机的隔爆结构具有Ex d I Mb、Ex d II AT4 Gb、Ex d II BT4 Gb。1)Exd I Mb适用于甲烷或煤尘爆炸性混合物存在的煤矿井下非采掘面环境；2)Ex d II AT4 Gb、Ex d II BT4 Gb适用于 II 类A级和 II 类B级，温度组别为 T1、T2、T3和T4组爆炸性混合物存在的环境。
2. 电动机主体外壳防护等级为IP55。
3. 电动机的冷却方式为IC411。
4. 电动机的绝缘等级为F级，定子绕组温升裕度大、寿命长。
5. 电动机有一个圆柱形轴伸，借联轴节或齿轮传动。
6. 电动机定子绕组采用高强度聚酯漆包圆铜线，并经VPI真空加压浸漆处理成为一个完整的整体，绕组及绝缘具有良好的电气、机械、防潮性能及热稳定性。
7. 电动机转子采用铸铝结构，转子经动平衡核检，电动机运转平稳、振动小、噪声低。
8. 电动机定、转子冲片采用高导磁、低损耗优质电工硅钢片，电动机损耗低、效率高。
9. 电动机轴承选用电动机专用低振动、低噪声轴承，机座号132及以下采用双面密封轴承，在轴伸端装有波形弹簧垫圈，以适度压力压靠轴承，有效抑制电动机运转时产生的振动和噪声，机座号160及以上采用内、外盖结构，并在轴承部位采用挡圈轴向固定，有效地防止电动机转子的轴向窜动。为使电动机安全可靠运行，机座号160及以上电动机轴承结构设置有注排油装置，机座号250及以上电动机，预留轴承温度监测传感元件位置。
10. 电动机风扇、风罩：该系列电动机采用防静电塑料风扇，其转动惯量小、损耗低，全系列风扇与轴采用键联接，运行可靠。风罩为钢板结构，在防止一定大小的外物侵入的前提下得到最大的通风面积，使风路通畅。

Construction Features

1. The flameproof constructions for Ex d I Mb, Ex d II AT4 Gb, Ex d II BT4 Gb are available.
 - 1) EXd I Mb is applicable for non-excavation area environment under coal mine well with methane or coal dust explosive mixture. 2) Ex d II AT4 Gb, Ex d II BT4 Gb is suitable for Category II, Class A & Category II, Class B, Temperature category T1, T2, T3, T4 at environment with explosive mixture existence.
2. The degree of protection is Ip55 for motor main enclosures
3. The cooling form is IC411.
4. The stator windings are of Class F insulation and ensures a large margin of safety in temperature rise and long service life.
5. A cylindrical shaft extension is equipped on motors, which is driven by coupling or spur gearing.
6. The stator windings are wound with polyester enamel round wire of high strength and then treated with the progress of vacuum-pressure impregnation(VPI), to make them become a solid integral. Therefore, the winding insulation is excellent in electrical and mechanical properties, moisture resistance and thermal stability.
7. The rotors are of cast-aluminum, and dynamically balanced to make the motor operate smoothly with small vibration and low noise.
8. The stator and rotor cores are laminated with high-class electrical steel sheet with high permeability and low loss, thus makes the motors possess low loss and high efficiency.
9. The motors are fitted with low vibration and low noise bearings special for motors. For the motors of frame size 132 and below, bilaterally shielded ball bearings are used and corrugated spring washers at the driving ends pressed on bearings with proper pressure to restrain effectively the vibration and noise produced during motors' operation. For the motors of frame size 160 and above, the bearings with inner and outer covers are used and retaining rings at bearing position are equipped on shafts to prevent the rotor efficiently from moving axially.

In order to operate safely and reliably, the bearings of the motors frame size 160 and above are provided with greasing attachments, which are of the use to drain or replenish the lubricating grease without stopping the motors. For the frame size 250 and above, the positions for mounting bearing temperature monitoring sensors are preliminary left.
10. Motor fan, air hood: The series motor adopts anti static plastic fan, with small rotational inertia and low loss. The series fan is connected with shaft by key with reliable operation. Air hood is of steel plate structure, It achieves largest ventilation area under the premise of preventing certain sizes of foreign matter from invasion, which obtains smooth air path.

电动机使用条件 Service Conditions

※ 电动机使用电气条件 Electrical Conditions

1. 额定电压 Rated voltage: 380、660、1140、380/660、660/1140V
2. 额定频率 Rated frequency: 50Hz
3. 定额 Duty type: 连续工作制S1 Continuous running duty-type S1

※ 电动机使用环境条件 Circumstance Conditions

海拔不超过1000m, 环境空气温度随季节而变化, 为-20℃~+40℃的户内型环境

The altitude is up to 1000m above sea level. The ambient temperature, which is subject to seasonal variation, belongs to indoor circumstance of -20℃~+40℃.

YB3为基本型, 适用于户内环境

YB3 IS THE BASIC TYPE, SUITABLE FOR INDOOR CIRCUMSTANCE

YB3-W 适用于户外型环境

YB3-W for outdoor circumstance

YB3-TH 适用于户内湿热带型环境

YB3-TH for indoor tropical humidity circumstance

YB3-WTH 适用于户外湿热带型环境

YB3-WTH for outdoor tropical humidity circumstance

YB3-TA 适用于户内干热带型环境

YB3-TA for indoor tropical arid circumstance

YB3-WTA 适用于户外干热带型环境

YB3-WTA for outdoor tropical arid circumstance

YB3-T 适用于户内热带型环境

YB3-T for indoor tropical circumstance

YB3-WT 适用于户外热带型环境

YB3-WT for outdoor tropical circumstance

YB3-WF1 适用于户外中等腐蚀的环境

YB3-WF1 for outdoor middle-class-chemical corrosion circumstance

电动机技术数据 Technical Data

1. 电动机机座号与功率及转速对应关系见表1

2. 电动机电气性能参数见表2

1. The correlation between frame size, output and speed are shown in Table 1

2. The electrical property parameters are shown in Table 2

YB3 系列隔爆型三相异步电动机 □□□□□□□□

Series YB3 Flameproof Three Phase Induction Motors

表 1 Table 1

机座号 Frame size	同步转速 Synchronous speed(r/min)				
	3000	1500	1000	750	600
功率 Output(kW)					
63M 1	0.18	0.12	—	—	—
	2	0.25			
71M 1	0.37	0.25	0.18	—	—
	2	0.55	0.37		
80M 1	0.75	0.55	0.37	0.18	—
	2	1.1	0.75	0.25	
90S	1.5	1.1	0.75	0.37	—
90L	2.2	1.5	1.1	0.55	
100L 1	3	2.2	1.5	0.75	—
		2		3	
112M	4	4	2.2	1.5	—
132S 1	5.5	5.5	3	2.2	
	2				7.5
132M 1	—	7.5	4	3	—
			2		
160M 1	11	11	7.5	4	—
	2			15	
160L	18.5	15	11	7.5	—
180M	22	18.5	—	—	
180L	—	22	15	11	—
200L 1	30	30	18.5	15	
	2		37		22
225S	—	37	—	18.5	—
225M	45	45	30	22	
250M	55	55	37	30	—
280S	75	75	45	37	
280M	90	90	55	45	—
315S	110	110	75	55	
315M	132	132	90	75	55
315L 1	160	160	110	90	75
	(185)	(185)	—	—	—
2	200	200	132	110	90
	(185)	(185)	160	132	(90)
355S 1	(200)	(200)			
355M 1	(220)	(220)	(185)	160	110
	2	250	200		132
355L 1	(280)	(280)	(220)	(185)	160
	2	315	315	250	200

注：1.带括号的为不优先推荐规格；

2.S、M、L后面的数字1、2分别代表同一机座号和转速下不同的功率。

Note:1.The specification in bracket is not preferentially recommended spec.

2.The numbers 1 and 2 following letters S,M and L represent separately different output in the same frame size at the same speed.

表 2 Table 2

型 号 Type	额 定 Rated		效 率 Efficiency %	功 率 因 数 Power factor COS ϕ	堵 转 转 矩 Locket torque Rated torque		堵 转 电 流 Locket current Rated current		最 大 转 矩 Pull out torque Rated torque	噪 声 Noise	振 动 等 级 Vibration class	转 动 惯 量 Inertia movement	重 量 Weight kg
	功 率 Output kW	电 流 Current (380V)A			转 速 Sync. Speed r/min	同 步 转 速 Synchronous speed 3000r/min							
YB3-80M1-2	0.75	1.8	77.4	0.83	1.5	6.8	2.3	67	1.3	0.0010	28		
YB3-80M2-2	1.1	2.5	79.6	0.83	1.5	7.3	2.3	67	1.3	0.0013	31		
YB3-90S-2	1.5	3.3	81.8	0.84	1.5	7.6	2.3	72	1.3	0.0020	36		
YB3-90L-2	2.2	4.7	83.2	0.85	1.4	7.8	2.3	72	1.3	0.0026	40		
YB3-100L-2	3	6.2	84.6	0.87	1.4	8.1	2.3	76	1.3	0.0042	50		
YB3-112M-2	4	8.0	85.8	0.88	1.4	8.3	2.3	77	1.3	0.0058	66		
YB3-132S1-2	5.5	10.9	87.0	0.88	1.2	8.0	2.3	80	1.3	0.0128	82		
YB3-132S2-2	7.5	14.5	88.1	0.89	1.2	7.8	2.3	80	1.3	0.0151	87		
YB3-160M1-2	11	21.0	89.4	0.89	1.2	7.9	2.3	86	1.8	0.0489	149		
YB3-160M2-2	15	28.4	90.3	0.89	1.2	8.0	2.3	86	1.8	0.0559	159		
YB3-160L-2	18.5	34.7	90.9	0.89	1.1	8.1	2.3	86	1.8	0.0648	172		
YB3-180M-2	22	41.0	91.3	0.89	1.1	8.2	2.3	88	1.8	0.0808	232		
YB3-200L1-2	30	55.7	92.0	0.89	1.1	7.5	2.3	90	1.8	0.163	289		
YB3-200L2-2	37	68.3	92.5	0.89	1.1	7.5	2.3	90	1.8	0.172	307		
YB3-225M-2	45	82.7	92.9	0.89	1.0	7.6	2.3	92	1.8	0.302	351		
YB3-250M-2	55	100.7	93.2	0.89	1.0	7.6	2.3	93	1.8	0.420	510		
YB3-280S-2	75	136.5	93.8	0.89	0.9	6.9	2.3	94	1.8	0.986	639		
YB3-280M-2	90	163.3	94.1	0.89	0.9	7.0	2.3	94	1.8	1.04	395		
YB3-315S-2	110	196.6	94.3	0.90	0.9	7.1	2.2	96	2.3	1.33	1075		
YB3-315M-2	132	235.6	94.6	0.90	0.9	7.1	2.2	96	2.3	1.50	1182		
YB3-315L1-2	160	281.8	94.8	0.91	0.9	7.1	2.2	98	2.3	1.67	1280		
YB3-315L2-2	200	351.5	95.0	0.91	0.8	7.1	2.2	98	2.3	1.88	1440		
YB3-355S1-2	(185)	323	95.0	0.91	0.8	7.1	2.2	98	2.3	2.88	1680		
YB3-355S2-2	(200)	345.8	95.0	0.91	0.8	7.1	2.2	98	2.3	3.05	1740		
YB3-355M1-2	(220)	380.4	95.0	0.91	0.8	7.1	2.2	100	2.3	3.67	1790		
YB3-355M2-2	(250)	439.4	95.0	0.91	0.8	7.1	2.2	100	2.3	4.02	1840		
YB3-355L1-2	(280)	482	95.0	0.91	0.8	7.1	2.2	100	2.3	4.16	2040		
YB3-355L2-2	315	553.6	95.0	0.91	0.8	7.1	2.2	100	2.3	4.86	2060		

注：重量为理论预算值。(参考) The weight is theoretic calculation (for reference).

YB3 系列隔爆型三相异步电动机 □□□□□□□□

Series YB3 Flameproof Three Phase Induction Motors

续表 2 (continued)

型号 Type	额定 Rated			效率 Efficiency %	功率因数 Power factor COSφ	堵转转矩 Locket torque		堵转电流 Locket current		最大转矩 Pull out torque	噪声 Noise	振动等级 Vibration class	转动惯量 Inertia movement	重量 Weight kg
	功率 Output kW	电流 Current (380V)A	转速 Sync. Speed r/min			额定转矩 Locket torque	额定转矩 Rated torque	额定电流 Locket current	额定电流 Rated current					
YB3-80M1-4	0.55	1.38	1435	79.0	0.75	2.3	2.3	6.3	2.3	2.3	58	1.3	0.0016	29
YB3-80M2-4	0.75	1.9	1435	79.6	0.75	2.3	2.3	6.5	2.3	2.3	58	1.3	0.0020	30
YB3-90S-4	1.1	2.7	1435	81.4	0.75	2.3	2.3	6.6	2.3	2.3	61	1.3	0.0030	37
YB3-90L-4	1.5	3.7	1440	82.8	0.75	2.3	2.3	6.9	2.3	2.3	61	1.3	0.0038	40
YB3-100L1-4	2.2	4.9	1455	84.3	0.81	2.3	2.3	7.5	2.3	2.3	64	1.3	0.0077	51
YB3-100L2-4	3	6.5	1455	85.5	0.82	2.3	2.3	7.6	2.3	2.3	64	1.3	0.0093	56
YB3-112M-4	4	8.6	1455	86.5	0.82	2.3	2.3	7.7	2.3	2.3	65	1.3	0.0128	72
YB3-132S-4	5.5	11.6	1460	87.7	0.82	2.0	2.0	7.5	2.3	2.3	71	1.3	0.0285	89
YB3-132M-4	7.5	15.5	1460	88.7	0.83	2.0	2.0	7.4	2.3	2.3	71	1.3	0.0366	102
YB3-160M-4	11	21.9	1470	89.8	0.85	2.2	2.2	7.5	2.3	2.3	75	1.8	0.0771	146
YB3-160L-4	15	29.3	1470	90.6	0.86	2.2	2.2	7.5	2.3	2.3	75	1.8	0.101	166
YB3-180M-4	18.5	35.8	1475	91.2	0.86	2.2	2.2	7.7	2.3	2.3	76	1.8	0.152	217
YB3-180L-4	22	42.3	1475	91.6	0.86	2.2	2.2	7.8	2.3	2.3	76	1.8	0.187	289
YB3-200L-4	30	57.4	1480	92.3	0.86	2.2	2.2	7.2	2.3	2.3	79	1.8	0.285	305
YB3-225S-4	37	70.5	1485	92.7	0.86	2.2	2.2	7.3	2.3	2.3	81	1.8	0.473	405
YB3-225M-4	45	85.4	1485	93.1	0.86	2.2	2.2	7.4	2.3	2.3	81	1.8	0.554	389
YB3-250M-4	55	103.9	1480	93.5	0.86	2.2	2.2	7.4	2.3	2.3	83	1.8	0.751	498
YB3-280S-4	75	137.8	1490	94.0	0.88	2.2	2.2	6.7	2.3	2.3	86	1.8	1.92	719
YB3-280M-4	90	165.0	1490	94.2	0.88	2.2	2.2	6.9	2.3	2.3	86	1.8	2.32	751
YB3-315S-4	110	201.0	1490	94.5	0.88	2.2	2.2	6.9	2.2	2.2	93	2.3	2.34	1091
YB3-315M-4	132	240.7	1490	94.7	0.88	2.2	2.2	6.9	2.2	2.2	93	2.3	2.58	1146
YB3-315L1-4	160	287.8	1490	94.9	0.89	2.2	2.2	6.9	2.2	2.2	94	2.3	2.96	1267
YB3-315L2-4	200	359.0	1490	95.1	0.89	2.2	2.2	6.9	2.2	2.2	94	2.3	3.46	1437
YB3-355S1-4	(185)	330.7	1488	95.1	0.90	2.2	2.2	6.9	2.2	2.2	94	2.3	6.02	1700
YB3-355S2-4	(200)	357.5	1488	95.1	0.90	2.2	2.2	6.9	2.2	2.2	94	2.3	6.30	1760
YB3-355M1-4	(220)	388.8	1488	95.1	0.90	2.2	2.2	6.9	2.2	2.2	95	2.3	6.42	1800
YB3-355M2-4	250	443.8	1488	95.1	0.90	2.2	2.2	6.9	2.2	2.2	95	2.3	6.60	1830
YB3-355L1-4	(280)	492.8	1488	95.1	0.90	2.2	2.2	6.9	2.2	2.2	95	2.3	6.77	2050
YB3-355L2-4	315	559.2	1488	95.1	0.90	2.2	2.2	6.9	2.2	2.2	95	2.3	7.55	2080

注：重量为理论计算值。(参考)The weight is theoretic calculation (for reference).

续表 2 (continued)

型号 Type	额定 Rated			效率 Efficiency %	功率因数 Power factor COSΦ	堵转转矩 Locket torque		堵转电流 Locket current		最大转矩 Pull out torque	噪声 Noise	振动等级 Vibration class	转动惯量 Inertia movement	重量 Weight kg
	功率 Output kW	电流 Current (380V)A	转速 Sync. Speed r/min			额定转矩 Rated torque	堵转转矩 Locket torque	额定电流 Rated current	堵转电流 Locket current					
同步转速 Synchronous speed 1000r/min														
YB3-80M1-6	0.37	1.27	890	62.6	0.70	1.9	1.9	4.7	2.0	54	1.3	0.0023	27.6	
YB3-80M2-6	0.55	1.54	890	75	0.72	1.9	1.9	4.7	2.1	54	1.3	0.0030	30	
YB3-90S-6	0.75	2.1	950	75.9	0.72	2.1	2.1	5.8	2.1	57	1.3	0.0038	35	
YB3-90L-6	1.1	2.9	950	78.1	0.73	2.1	2.1	5.9	2.1	57	1.3	0.0053	40	
YB3-100L-6	1.5	3.9	955	79.8	0.74	2.1	2.1	6.0	2.1	61	1.3	0.0107	48	
YB3-112M-6	2.2	5.5	955	81.8	0.74	2.1	2.1	6.0	2.1	65	1.3	0.0151	62	
YB3-132S-6	3	7.4	975	83.3	0.74	2.0	2.0	6.2	2.1	69	1.3	0.0318	87	
YB3-132M1-6	4	9.7	975	84.6	0.74	2.0	2.0	6.8	2.1	69	1.3	0.0394	95	
YB3-132M2-6	5.5	13.0	975	86.0	0.75	2.0	2.0	7.1	2.1	69	1.3	0.0404	103	
YB3-160M-6	7.5	16.8	980	87.2	0.78	2.1	2.1	6.7	2.1	73	1.8	0.0964	147	
YB3-160L-6	11	23.9	980	88.7	0.79	2.1	2.1	6.9	2.1	73	1.8	0.127	175	
YB3-180L-6	15	31.4	980	89.7	0.81	2.0	2.0	7.2	2.1	73	1.8	0.201	230	
YB3-200L1-6	18.5	38.4	985	90.4	0.81	2.1	2.1	7.2	2.1	76	1.8	0.325	279	
YB3-200L2-6	22	44.8	980	90.9	0.82	2.1	2.1	7.3	2.1	76	1.8	0.371	284	
YB3-225M-6	30	61.4	980	91.7	0.81	2.0	2.0	7.1	2.1	76	1.8	0.533	356	
YB3-250M-6	37	72.6	990	92.2	0.84	2.1	2.1	7.1	2.1	78	1.8	0.877	465	
YB3-280S-6	45	85.8	990	92.7	0.86	2.1	2.1	7.2	2.0	80	1.8	1.85	589	
YB3-280M-6	55	104.4	990	93.1	0.86	2.1	2.1	7.2	2.0	80	1.8	2.12	655	
YB3-315S-6	75	143.1	995	93.7	0.85	2.0	2.0	6.7	2.0	85	2.3	2.61	1074	
YB3-315M-6	90	173.2	995	94.0	0.84	2.0	2.0	6.7	2.0	85	2.3	3.04	1170	
YB3-315L1-6	110	208.5	995	94.3	0.85	2.0	2.0	6.7	2.0	85	2.3	3.71	1295	
YB3-315L2-6	132	246.5	995	94.6	0.86	2.0	2.0	6.7	2.0	85	2.3	4.24	1450	
YB3-355S-6	160	294.8	995	94.8	0.87	2.0	2.0	6.7	2.0	92	2.3	7.44	1770	
YB3-355M1-6	185	343	995	94.8	0.87	2.0	2.0	6.7	2.0	92	2.3	7.7	1820	
YB3-355M2-6	200	367.7	995	95.0	0.87	2.0	2.0	6.7	2.0	92	2.3	9.10	1850	
YB3-355L1-6	220	408	995	95.0	0.87	2.0	2.0	6.7	2.0	92	2.3	9.8	2070	
YB3-355L2-6	250	459.6	995	95.0	0.87	2.0	2.0	6.7	2.0	92	2.3	10.80	2130	

注：重量为理论计算值。(参考) The weight is theoretic calculation (for reference).

YB3 系列隔爆型三相异步电动机 □□□□□□□□

Series YB3 Flameproof Three Phase Induction Motors

续表 2 Table 2 (continued)

型号 Type	额定 Rated			效率 Efficiency %	功率因数 Power factor COSφ	堵转转速 Locket speed 750r/min		堵转电流 Locket current	最大转矩 Pull out torque		噪声 Noise	振动等级 Vibration class	转动惯量 Inertia movement	重量 Weight kg
	功率 Output kW	电流 Current (380V)A	转速 Sync. Speed r/min			额定转矩 Locket torque	同步转速 Synchronous speed		750r/min	额定转矩 Rated torque				
YB3-100L2-8	1.1	3.31	690	72	0.69	1.8	5.0	2.0	59	1.3	0.0102	49		
YB3-112M-8	1.5	4.0	690	74	0.70	1.8	5.0	2.0	61	1.3	0.0147	65		
YB3-132S-8	2.2	5.78	710	79	0.71	1.8	6.0	2.0	64	1.3	0.0307	83		
YB3-132M-8	3	7.69	710	80	0.73	1.8	6.0	2.0	64	1.3	0.0426	94		
YB3-160M1-8	4	9.7	720	81	0.73	1.9	6.0	2.0	68	1.8	0.0635	132		
YB3-160M2-8	5.5	13.0	720	83	0.74	1.9	6.0	2.0	68	1.8	0.0897	144		
YB3-160L-8	7.5	16.9	720	85.5	0.75	1.9	6.0	2.0	68	1.8	0.1270	166		
YB3-180L-8	11	24.8	720	87.5	0.75	2.0	6.5	2.0	70	1.8	0.2138	223		
YB3-200L-8	15	33.6	730	88.0	0.76	2.0	6.6	2.0	73	1.8	0.3588	279		
YB3-225S-8	18.5	40.2	740	90.0	0.76	1.9	6.6	2.0	73	1.8	0.5488	332		
YB3-225M-8	22	47.0	740	90.5	0.78	1.9	6.6	2.0	73	1.8	0.8454	363		
YB3-250M-8	30	64.0	740	91	0.79	1.9	6.5	2.0	75	1.8	0.9876	478		
YB3-280S-8	37	78.0	740	91.5	0.79	1.9	6.6	2.0	76	1.8	1.7092	585		
YB3-280M-8	45	95.0	740	92	0.79	1.9	6.6	2.0	76	1.8	1.9875	648		
YB3-315S-8	55	110.7	740	92.8	0.81	1.8	6.6	2.0	82	2.3	3.9597	972		
YB3-315M-8	75	151	740	93.5	0.81	1.8	6.2	2.0	82	2.3	5.2790	1080		
YB3-315L1-8	90	179.9	740	93.8	0.82	1.8	6.4	2.0	82	2.3	6.2695	1226		
YB3-315L2-8	110	217.2	740	94.0	0.82	1.8	6.4	2.0	82	2.3	7.4245	1310		
YB3-355S-8	132	259.6	740	93.7	0.82	1.8	6.4	2.0	90	2.3	11.4275	1405		
YB3-355M-8	160	314.7	740	94.2	0.82	1.8	6.4	2.0	90	2.3	13.9360	1880		
YB3-355L1-8	185	363.5	740	94.2	0.82	1.8	6.4	2.0	90	2.3	16.1657	1978		
YB3-355L2-8	200	387.0	740	94.5	0.83	1.8	6.4	2.0	90	2.3	18.1168	2130		
YB3-315S-10	45	99.4	592	91.5	0.75	1.5	6.2	2.0	82	2.3	3.8772	972		
YB3-315M-10	55	120.1	592	92.0	0.75	1.5	6.2	2.0	82	2.3	4.7846	1080		
YB3-315L1-10	75	162	592	92.5	0.76	1.5	5.8	2.0	82	2.3	6.1870	1226		
YB3-315L2-10	90	190.5	592	93.0	0.77	1.5	5.9	2.0	82	2.3	7.2595	1310		
YB3-355S-10	90	190.3	585	93.0	0.77	1.5	6.0	2.0	82	2.3	9.3540	1405		
YB3-355M1-10	110	229.6	585	93.2	0.78	1.3	6.0	2.0	90	2.3	11.4481	1880		
YB3-355M2-10	132	274.7	585	93.5	0.78	1.3	6.0	2.0	90	2.3	13.9612	1960		
YB3-355L1-10	160	332.9	585	93.5	0.78	1.3	6.0	2.0	90	2.3	17.3118	2086		
YB3-355L2-10	185	385	585	93.5	0.78	1.3	6.0	2.0	90	2.3	19.9645	2130		

注：重量为理论计算值。(参考)The weight is theoretic calculation (for reference).

表3 Table 3

机座号 Frame size	结构与安装型式代号 Sample of constructions and mounting arrangements (IM)
63~71	B3,B5,B6,B7,B8,B14,B34,V1,V3,V5,V6,V18
80~112	B3,B5,B6,B7,B8,B14,B34,B35,V1,V3,V5,V6,V15,V18,V35,V37
132~160	B3,B5,B6,B7,B8,B35,V1,V3,V5,V6,V15,V35,V37
180~280	B3,B5,B35,V1
315~355	B3,B35,V1

表4 Table 4











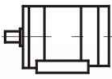
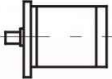

安装结构型式 Constructions and mounting arrangements	B3	B5	B6	B7	B8
示意图 Illustrated diagram					
安装结构型式 Constructions and mounting arrangements	B14	B34	B35	V1	V3
示意图 Illustrated diagram					
安装结构型式 Constructions and mounting arrangements	V5	V6	V15	V18	V35
示意图 Illustrated diagram					

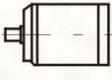
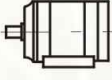
表5 Table 5

接线盒规格 Specifications of terminal box	适用机座号 For frame size	进线口数 Number of entry	进线电缆 最大外径 The max. outer diameter of inlet cable	钢管布线 进线口螺纹 Thread of conduit entry	正常供货范围 Scope of supply
小M5	80~100	单 One	Φ25	M30×2	正常 Normal
M5	112~132	单 One	Φ25	M30×2	正常 Normal
M6	160~180	单 One	Φ35	M36×2	正常 Normal
M8	200~225	单 One	Φ42	M48×2	正常 Normal
M10	250~280	单 One	Φ50	M64×2	正常 Normal
M10	250~280	双 Two	Φ42	M48×2	正常 Normal
M16	315~355	双 Two	Φ50	M64×2	正常 Normal
M16	315~355	双 Two	Φ64	M72×2	正常 Normal

YB3 系列隔爆型三相异步电动机

Series YB3 Flameproof Three Phase Induction Motors

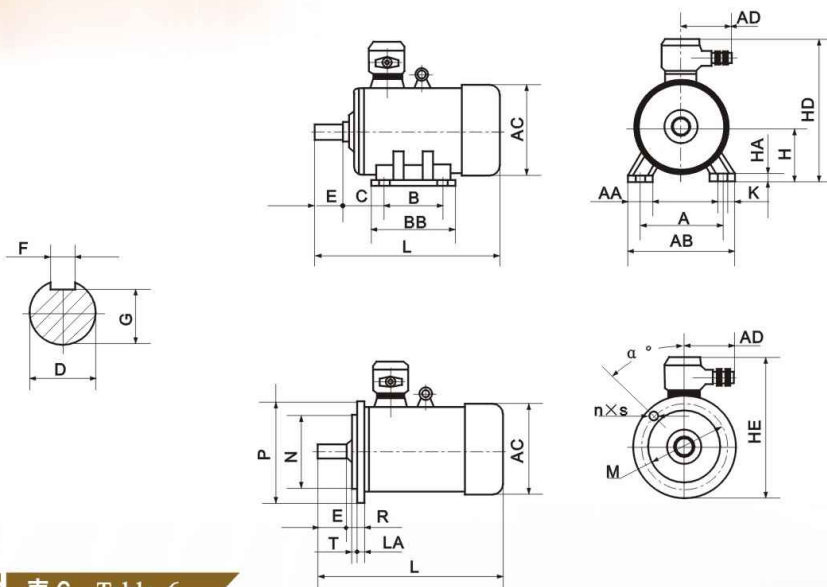

IMB3

IMB5

表6 Table 6

机座号 Frame size	凸缘号 Flange number		安装及外形尺寸																			
	IMB35 IMB5 IMV1	IMB14 IMB34	A	B	C	极数 Pole number								H	K	凸缘尺寸						
						D		E		F		G				M	N	P	R	α°	n x S	T
						2P	$\geq 4P$	2P	$\geq 4P$	2P	$\geq 4P$	2P	$\geq 4P$									
63	FF115	FF75	100	80	40	11	23	4	8.5	63	7	115	95	140	0	45	4 x Φ 10	3.0				
71	FF130	FF85	112	90	45	14	30	5	11	71	7	130	110	160	0	45	4 x Φ 10	3.0				
80	FF165	FF100	125	100	50	19	40	6	15.5	80	10	165	130	200	0	45	4 x Φ 12	3.5				
90S	FF165	FF115	140	100	56	24	50	8	20	90	10	165	130	200	0	45	4 x Φ 12	3.5				
90L	FF165	FF115	140	125	56	24	50	8	20	90	10	165	130	200	0	45	4 x Φ 12	3.5				
100L	FF215	FF130	160	140	63	28	60	8	24	100	12	215	180	250	0	45	4 x Φ 14.5	4.0				
112M	FF215	FF130	190	140	70	28	60	8	24	112	12	215	180	250	0	45	4 x Φ 14.5	4.0				
132S	FF265		216	140	89	38	80	10	33	132	12	265	230	300	0	45	4 x Φ 14.5	4.0				
132M	FF265		216	178	89	38	80	10	33	132	12	265	230	300	0	45	4 x Φ 14.5	4.0				
160M	FF300		254	210	108	42	110	12	37	160	14.5	300	250	350	0	45	4 x Φ 18.5	5.0				
160L	FF300		254	254	108	42	110	12	37	160	14.5	300	250	350	0	45	4 x Φ 18.5	5.0				
180M	FF300		279	241	121	48	110	14	42.5	180	14.5	300	250	350	0	45	4 x Φ 18.5	5.0				
180L	FF300		279	279	121	48	110	14	42.5	180	14.5	300	250	350	0	45	4 x Φ 18.5	5.0				
200L	FF350		318	305	133	55	110	16	49	200	18.5	350	300	400	0	45	4 x Φ 18.5	5.0				
225S	FF400		356	286	149	55	60	110	140	16	18	49	53	225	18.5	400	350	450	0	22.5	8 x Φ 18.5	5.0
225M	FF400		356	311	149	55	60	110	140	16	18	49	53	225	18.5	400	350	450	0	22.5	8 x Φ 18.5	5.0
250M	FF500		406	349	168	60	65	140	140	18	18	53	58	250	24	500	450	550	0	22.5	8 x Φ 18.5	5.0
280S	FF500		457	368	190	65	75	140	140	18	20	58	67.5	280	24	500	450	550	0	22.5	8 x Φ 18.5	5.0
280M	FF500		457	419	190	65	75	140	140	18	20	58	67.5	280	24	500	450	550	0	22.5	8 x Φ 18.5	5.0
315S	FF600		508	406	216	65	80	140	170	18	22	58	71	315	28	600	550	660	0	22.5	8 x Φ 24	6.0
315M	FF600		508	457	216	65	80	140	170	18	22	58	71	315	28	600	550	660	0	22.5	8 x Φ 24	6.0
315L	FF600		508	508	216	65	80	140	170	18	22	58	71	315	28	600	550	660	0	22.5	8 x Φ 24	6.0
355S	FF740		610	500	254	75	95	140	170	20	25	67.5	86	355	28	740	680	800	0	22.5	8 x Φ 24	6.0
355M	FF740		610	560	254	75	95	140	170	20	25	67.8	86	355	28	740	680	800	0	22.5	8 x Φ 24	6.0
355L	FF740		610	630	254	75	95	140	170	20	25	67.5	86	355	28	740	680	800	0	22.5	8 x Φ 24	6.0

大中电机

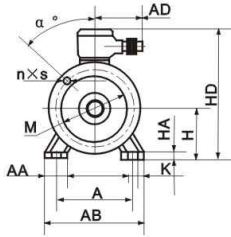
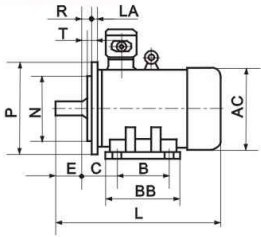

IMB35

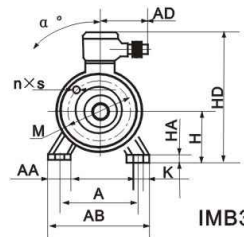
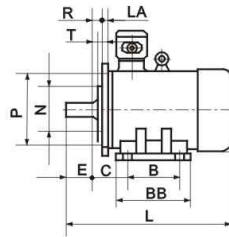

IMB34

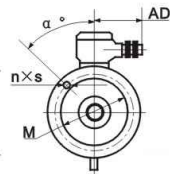
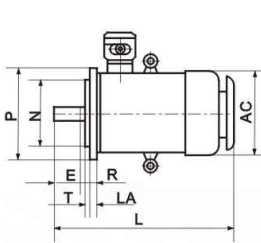

IMV1

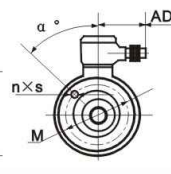
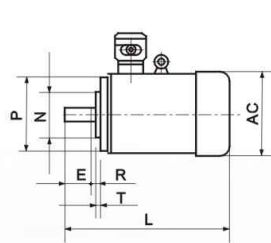

IMB14

mm

Mounting and overall dimensions

Flange dimensions

进线口管螺纹
Thread of
conduit entry

L

IMB14		IMB34		n x S	T	进线口管螺纹 Thread of conduit entry		AA	AB	AC	AD	BB	HA	HD	HE	L _A	L				
M	N	P	R			α°	单口 One entry										双口 Two entries	2P		≥4P	
							其它 Other	V ₁	其它 Other	V ₁											
75	60	90	0	45	4×M5	2.5	M24×1.5		30	130	130	110	110	8	230	230	10	270	310	270	310
85	70	105	0	45	4×M6	2.5	M24×1.5		32	145	145	110	130	8	240	240	12	300	340	300	340
100	80	120	0	45	4×M6	3.0	M30×2		34	165	165	180	135	10	340	340	12	330	375	330	375
115	95	140	0	45	4×M8	3.0	M30×2		36	180	180	180	135	14	355	355	14	370	415	370	415
115	95	140	0	45	4×M8	3.0	M30×2		36	180	180	180	160	14	355	355	14	395	440	395	440
130	110	160	0	45	4×M8	3.5	M30×2		43	200	205	180	180	14	360	400	14	448	485	448	485
130	110	160	0	45	4×M8	3.5	M30×2		50	245	225	200	180	16	380	420	14	500	560	500	560
							M30×2		60	280	265	200	190	18	470	490	14	550	610	550	610
							M30×2		60	280	265	200	230	18	470	490	14	600	660	600	660
							M36×2		70	330	320	220	260	20	500	520	15	720	710	720	780
							M36×2		70	330	320	220	310	20	500	520	15	750	810	750	810
							M36×2		70	355	360	220	315	25	540	540	18	770	830	770	830
							M36×2		70	355	360	220	355	25	540	540	18	790	830	770	830
							M48×2		70	390	400	250	370	25	650	650	18	850	920	850	920
							M48×2		75	435	450	250	360	28	695	695	18	890	960	890	960
							M48×2		75	435	450	250	385	28	695	695	18	920	990	920	990
							M64×2	M48×2	80	490	500	275	430	30	730	755	20	965	1055	965	1055
							M64×2	M48×2	85	545	560	275	455	35	800	795	22	1010	1100	1010	1100
							M64×2	M48×2	85	545	560	275	505	35	800	795	22	1060	1150	1060	1150
							M64×2	M64×2	120	635	630	350	630	45	960	975	25	1240	1340	1270	1370
							M64×2	M64×2	120	635	630	350	630	45	960	975	25	1240	1340	1270	1370
							M64×2	M64×2	120	635	630	350	780	45	960	975	25	1390	1490	1420	1520
							M72×2	M72×2	150	735	710	350	710	52	1030	1145	25	1450	1590	1480	1620
							M72×2	M72×2	150	735	710	350	710	52	1030	1145	25	1450	1590	1480	1620
							M72×2	M72×2	150	735	710	350	810	52	1030	1145	25	1550	1690	1580	1720

电动机结构及安装型式和安装外形尺寸

※ 电动机结构及安装型式

本系列电动机的安装方式符合GB997《电机结构及安装型式代号》及IEC34-7的规定。本系列电动机有5种基本结构型式：

- B3—机座带底脚、端盖无凸缘；
- B5—机座不带底脚、端盖有凸缘；
- B35—机座带底脚、端盖有凸缘；
- B14—机座不带底脚、端盖有小凸缘；
- B34—机座带底脚、端盖有小凸缘；

本系列电动机在上述5种基本结构上，可派生15种常用结构及安装型式，其制造范围见表3。结构及安装型式示意图见表4。

※ 电动机接线盒结构

电动机接线盒结构具有优良的隔爆性能和较高防护等级，且具有较大的空腔以便于接线，进线分为橡胶套电缆，钢管布线两种。按不同起动要求，可分别制成一个进线口（适用于电动机直接起动）和两个进线口（适用于电动机Y- Δ 起动）。接线盒进线口及适用范围见表5。

※ 电动机安装外形尺寸见表6。

Constructions, Mounting Arrangements and Overall Dimensions

※ Constructions and Mounting Arrangements

The mounting arrangements of this series motors conform to China Standards GB997 *Sample for types of construction and mounting arrangement of rotating electrical machinery* and IEC Publication 34-7.

- Five basic constructions are available:
- B3 --- with foot mounted and flangeless,
 - B5 --- with flange mounted and footless,
 - B35 --- with both foot and flange mounted,
 - B14 --- with small flange mounted and footless and
 - B34 --- with both foot and small flange mounted.

Based on five constructions mentioned above, this series motors can be modified into 15 constructions and mounting arrangements. For the manufacture range, see Table 3. And for the constructions and mounting arrangements, see Table 4.

※ Motor Terminal Construction

The motor junction box structure is with excellent flameproof performance and high protection level, it has larger cavity to facilitate wiring. There are two kinds of incoming wirings: rubber-sheathed cable, steel pipe wiring. As per different starting requirement, it can be made into one inlet (applicable for motor direct starting) and two inlets (applicable for motor Y- Δ starting). Pls refer to table 5 for junction box inlet and scope of Application.

※ For the mounting and overall dimensions, see Table 6.

大 中 电 机

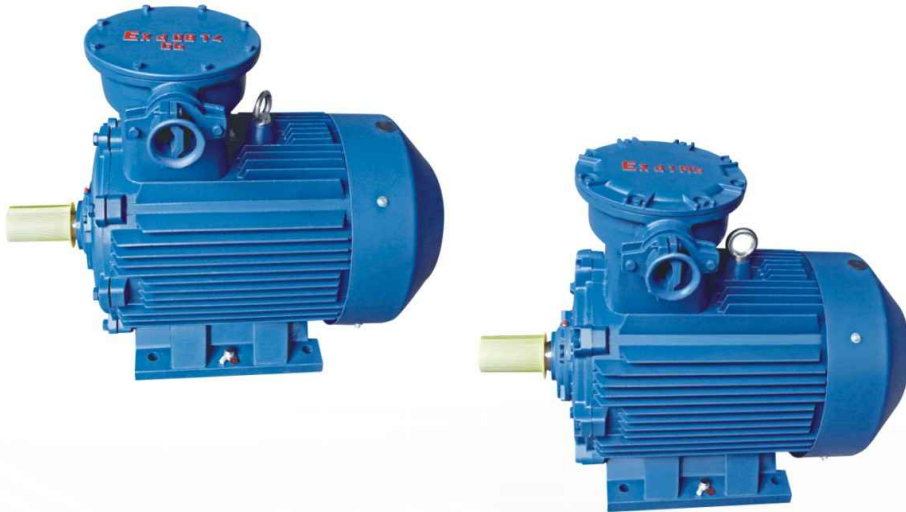

(矿用) Mine

订货指南

1. 本样本中的数据随着技术进步允许有变动，不另行通知，请注意样本的出版日期。
2. 如有特殊要求，如电压、频率、防护等级、旋转方向、双轴伸、噪声振动限值、转速（双速、三速或四速）等等必须签订技术协议后，方可制造。
3. 订货时请按样本中所标明的电动机的型号、功率、同步转速、电压、频率、结构及安装型式、防爆标志、隔爆等级和接线盒进线方式以及旋转方向等等。
例：机座中心高为355，220kW，2P，机座带底脚，端盖无凸缘，工厂用ⅡB类T4组隔爆型，380V，顺时针转向，橡套电缆进线的电动机标注如下：
YB3-355M1-2 220kW 3000r/min 380V 50Hz IMB3 Ex dⅡB T4Gb橡套电缆，顺时针旋转。

Ordering Requirements

1. Since the technique is developing continuously, the data in this catalogue may be subject to alteration without prior notice. Please note the publication date by month and year.
2. For the special requirements, such as voltage, frequency, protection degree, rotating direction, two shaft extension ends, limiting values of noise and vibration, speed (two-speed, three-speed or four-speed) etc, the motors will not be manufactured until a technical specification being signed.
3. When placing orders, pls follow motor model, power, synchronous speed, voltage, frequency, structure and installation type, explosive-proof mark, flameproof grade and junction box incoming way and revolution direction etc. specified in brochure.
Example: base center height of 355, 220kW, 2P, frame with feet, end cover without flange, factories with class II B group T4 flameproof type, 380V, veering, rubber sets of cables into linear motor marked as follows:
YB3-355M1-2, 220kW, 3000r/min, 380V, 50Hz, IMB3, ExdⅡBT4 Gb, rubber-insulated cable entry and clockwise rotation.